

t=0.3 sec

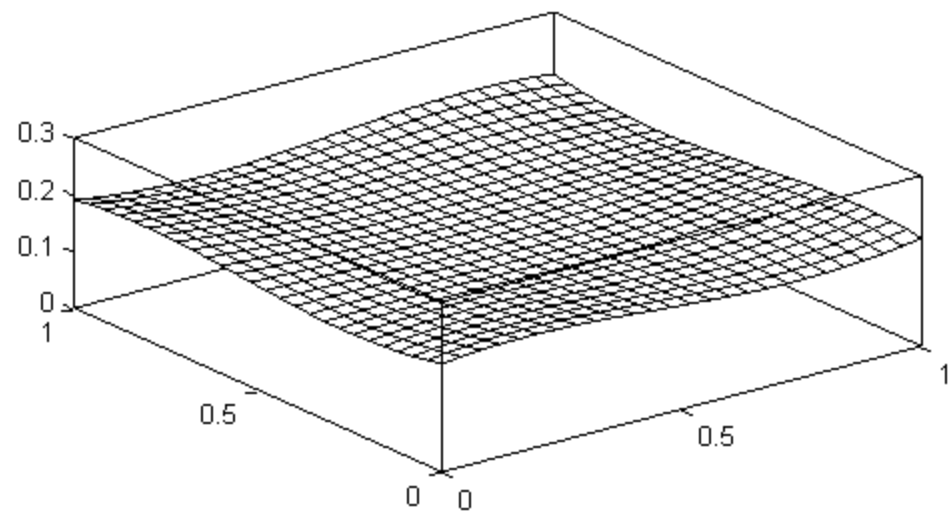

t=0.7 sec

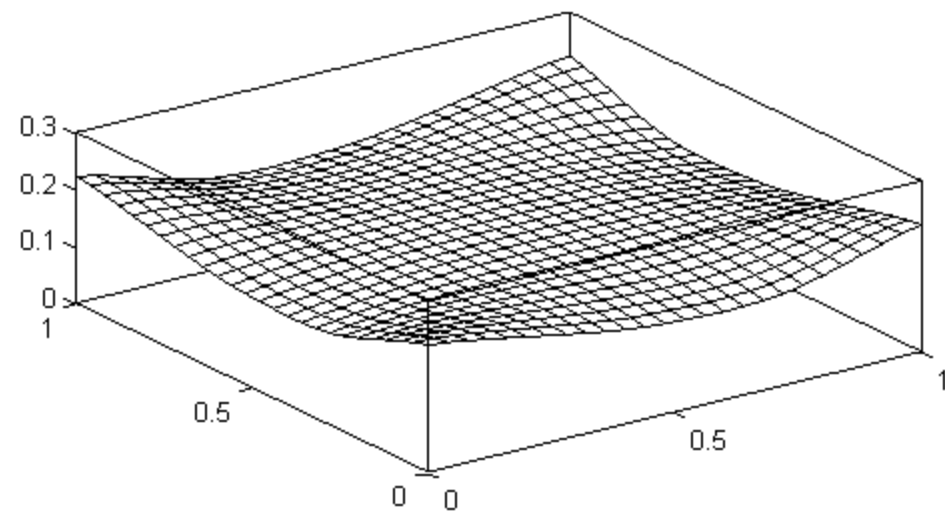

t=1.1 sec

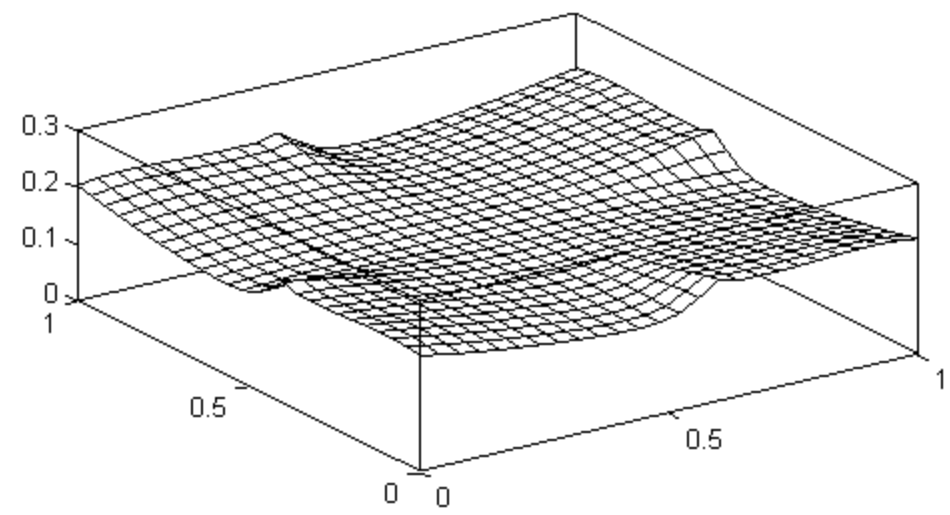

t=1.4 sec

