

**t=4.0 sec**

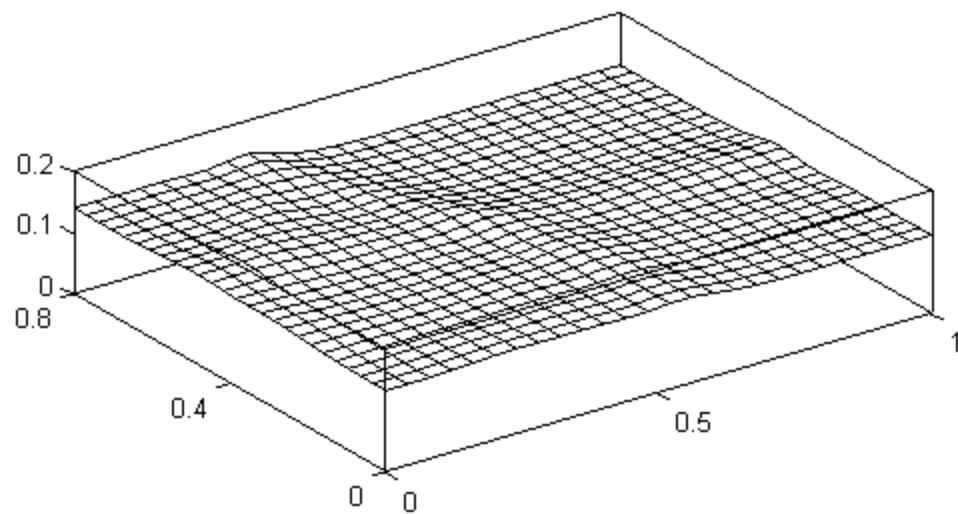

**t=4.5 sec**

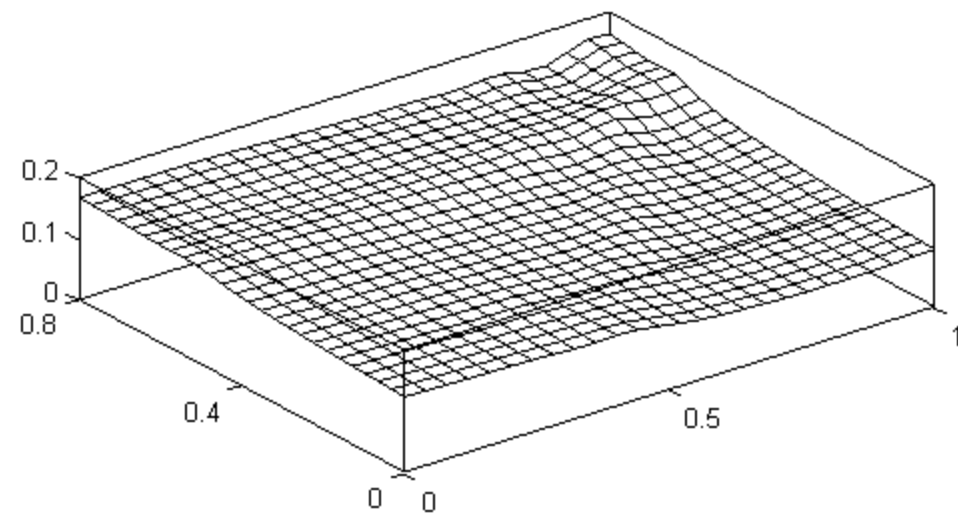

**t=5.5 sec**

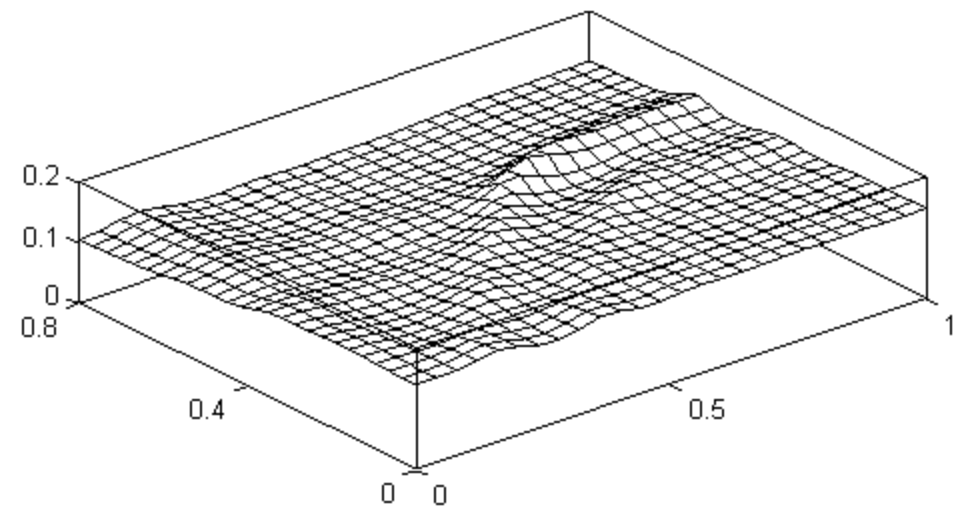

**t=6.0 sec**

